

2-Tier IntelliSolar Fountain with Remote Control

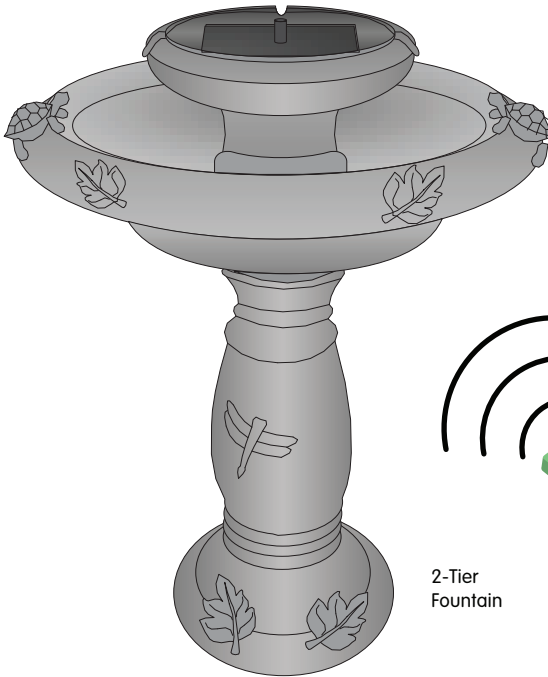

* Styles may vary but assembly will be consistent with this manual



2-Tier Fountain

Warning! Important Read Me!



In strong sunlight or windy conditions, the water may splash outside of the birdbath. We recommend the water be regularly topped off and changed to ensure it remains clean and free from debris.

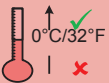

Important!

Frost / freezing temperatures cause damage. Empty water and store whole product indoors (garage, shed, basement) during winter if you live in an area where temps fall below 40°F. Leaving it outside and covering it does not count as winter storage. Any parts damaged by freezing temps are not covered under warranty.

Fountain Heads

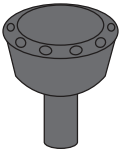

The 360° fountain head accessory can be used to enhance your fountain. Note: It will only work effectively in bright sunlight or if battery is charged.



The short nozzle can be used to produce a finer higher stream of water.

Note: May need to be removed when windy to avoid splashing.

Components

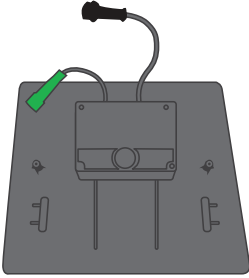

Solar Panel (part A)
(Assembled inside part I)

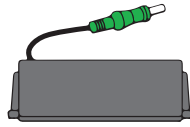

Rechargeable Battery (part B)
(Attached to bottom of part A)

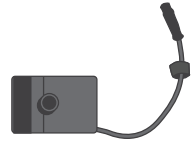

Pump with water sensor (part C)
(Assembled inside part I)

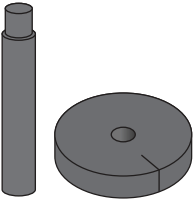

Two Tier Tube Kit (part D)
(Assembled inside part I)

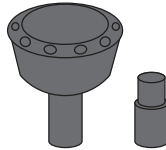

Fountain Head Set (part E)

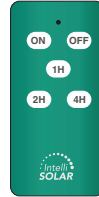

Remote Control (part F)

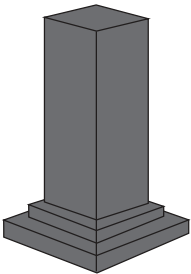

Stand* (part G)

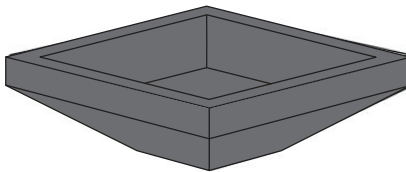

Bowl* (part H)

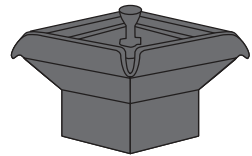

Top Tier* (part I)
(includes A, B, C, D)

*The shape and style of the Stand, Bowl, and Top Tier will vary based on which fountain you purchased.

Plug Connection for Pump

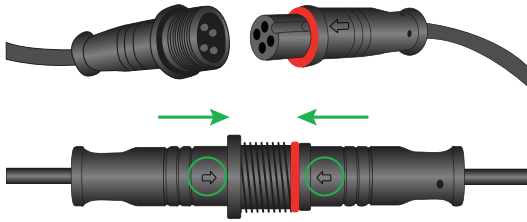

BEFORE USE: Ensure that the plug connection is water tight.

(Step 1) Line up arrows on plugs

(Step 2) Push plugs together until they touch the rubber o-ring.

(Step 3) Slide the threaded cap over the plug.

(Step 4) Turn the cap until completely tight.

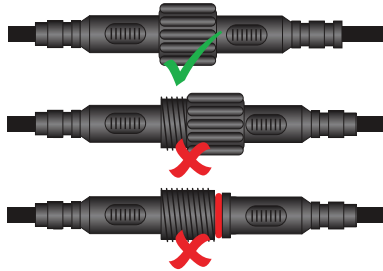

Plug Connection for Battery

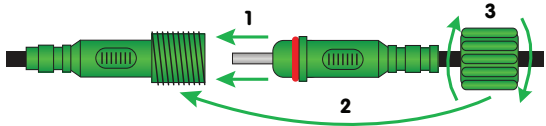

BEFORE USE: Ensure that the plug connection is water tight.

(Step 1) Push plugs together until they touch the rubber o-ring.

(Step 2) Slide the threaded cap over the plug.

(Step 3) Turn the cap until completely tight.

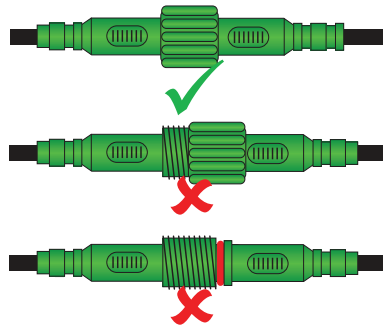

Assembly

The solar kit (parts A, B, C, D) are already assembled inside the top tier (I) as shown in the cross section diagram. The rechargeable battery pack (B) is already attached to the bottom of the solar panel (A) but the plugs are not connected to preserve battery life. You will just need to connect the green set of plugs under the panel to plug the battery into the panel, then set the panel into place, hold in down, and push the pump up to insert the tube into the bottom of the panel. When done correctly the panel will not lift out easily. If desired you can add the optional fountain head nozzle/sprayer (E) on top.

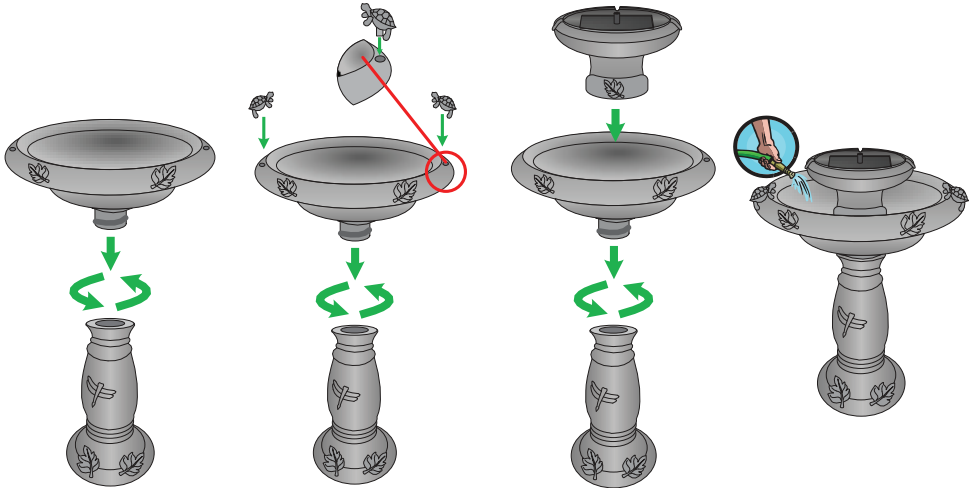
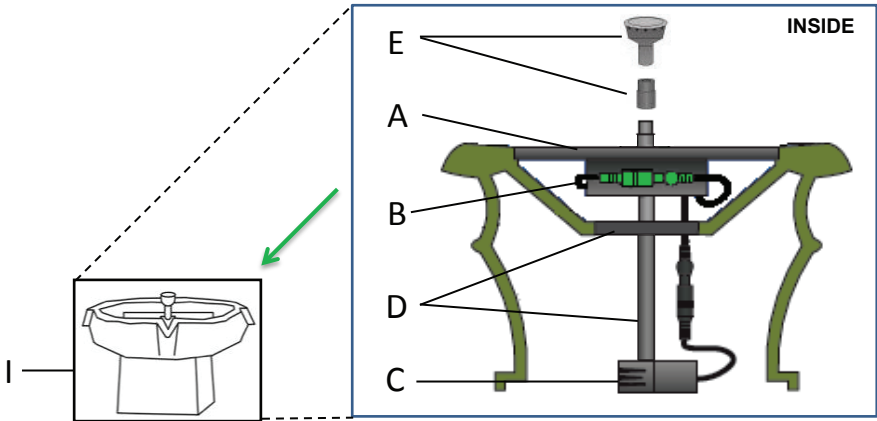

Attach bowl to pedestal. Align the marks and turn to lock in place.

If your fountain includes accents, locate the pin on the accent pieces and insert into the holes around the edge of the bowl.

Connect upper tier components. Place upper tier into the main bowl

Fill bowl with water.

Location

Position your solar fountain outside in direct sun. The more hours of direct sun the better it will perform. If the fountain does not receive any direct sun then the battery will not get charged resulting in poor performance. After the battery is charged then it can run in any location or conditions. Please see the "Operation" section for more info.

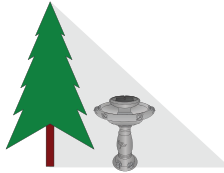
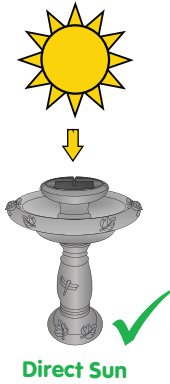

No Shade

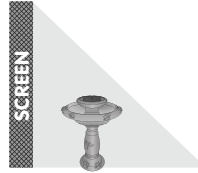

No Screens

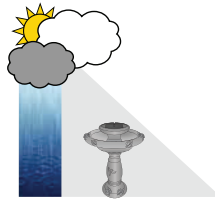

No Clouds



**No Windows
No Indoor Light**

Weather	When Fountain Turned On...	When Fountain Turned Off...
Sunny No Clouds	Direct sun runs the pump and any extra energy will trickle charge the battery at the same time.	Battery should fully charge in 1 sunny day.
Light Overcast Partly Cloudy	As clouds pass the battery will automatically activate when needed to keep the pump running consistently so the battery will get used throughout the day.	Battery may take 2-3 days to fully charge with light overcast.
Heavy Overcast Dark Clouds	The battery will run the pump if the battery is charged. When the battery is depleted the pump will stop running.	Battery will not charge when very cloudy.
Dusk to Dawn Night	At night the pump will only run if the battery is charged. When the battery is depleted, the pump will stop running.	Battery will not charge in the evening when the sun is too low or at night.

When in direct sun or the battery is fully charged

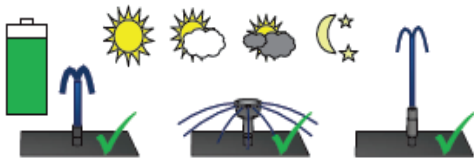

When not in the sun and the battery is low

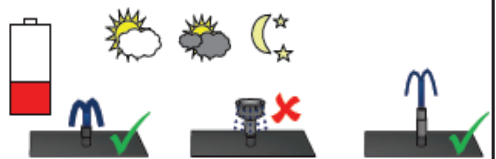

Auto On/Off Water Sensor

Water Level Sensor

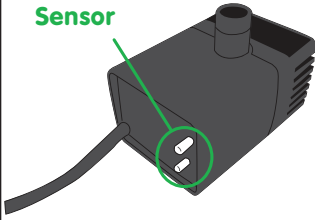

This fountain features our Pump Protection Technology. The pump is equipped with a built in water sensor that uses 2 metal prongs on the back side. If the water level gets low due to evaporation or splashing when the 2 metal prongs on the pump are dry the pump will automatically stop running to protect it from running dry and burning out. When you fill the fountain up again and the pump is completely underwater it will automatically start running again.

NOTE:

If the water level is low but the prongs are still wet the pump will continue running until the prongs are dry.

Operation: How Does It Work?

This unit is programmed so the water sensor on the pump overrides the remote. This means that if the pump is submerged and you turn it ON using the remote, then take it out of the water, the pump will stop running when the metal prongs become dry. While it's dry, the pump will not run even if the battery is charged and you try to turn it on using the remote. If you then place the pump back in the water so the prongs are wet, the sensor on it will make it automatically start running again if in direct sun or the battery is charged.

If the pump is submerged and you use the remote to turn the unit OFF, then later the water sensor prongs becomes dry (either from someone lifting it out of the water or from evaporation during summer), and then it gets put back in the water or you add water or it rains so pump is submerged again then it will automatically start running. This is an example of why you might think it started running on its own after you used the remote to turn it off but it's functioning normally. If the pump is ever running when not in water, clean off the water sensor prongs on the pump and dry them off then the pump should stop.

During a typical summer with consecutive sunny days, if you don't feel like turning it on and off and just let it run all day and don't use the remote that's ok. Once it's running, it will run during the day using the sun and whenever a cloud passes the battery automatically keeps the pump running. When in shade or in the evening it will run as long as it can until the battery is depleted. Once this happens you'll need to wait until the next day for it to work again. When the sun rises the next day and first hits the panel early in the morning but it's still too low in the sky, you may notice the water spurt up repeatedly. This is normal until the sun is higher and strong enough to run the pump consistently for the day. If you do decide to press the 1H, 2H or 4H button on the remote it will run for that amount of time, then automatically turn off and save the remaining charge in the battery. The timer is helpful in the evening so that the battery keeps some power for the next morning.

If you have several consecutive cloudy days, and the battery has been deplete, then the fountain may not run and battery may get charged until you have a sunny day again.

Manual Start

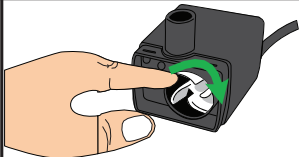

If the pump is not working try to manually start it. Remove the front filter cover, have the solar panel in direct sun, have the metal prongs on the back of the pump in water, and spin the white impeller fan clockwise for up to 1 minute

Remote Control

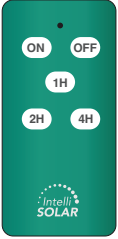

Our IntelliSolar technology comes with a remote so you can control your fountain from a distance. It has buttons for On, Off, 1hr, 2hr, and 4hr hour timers. If you press the ON button and the pump is under water then it will run as long as it can until the battery is depleted. If you can press one of the timer buttons you can enjoy the fountain now and save any leftover charge in the battery for later. If you press the OFF button you can charge the battery while the solar panel is in the sun.

LOST YOUR REMOTE? NO WORRIES!

We designed this solar kit so that if you ever lose or break your remote you can still use your fountain. If you don't have the remote and want the pump to stop running simply take it out of the water, dry off the pins on the back of the pump, and it will automatically stop running. When you place it back in the water the pump will automatically start running again (if in direct sun or the battery is charged). You can order a replacement remote from our parts dept online, by email or phone.

How to Replace Battery in Remote



When you press any button on the remote a red light will illuminate. If not, you may need to replace the battery in the remote.

(Step 1) Push in the tab on the right side to release it.

(Step 2) While holding in the tab slide the tray out.

(Step 3) Replace the battery and install tray.

3V Coin Battery
Model# CR2025

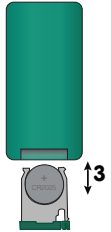

WARNING

- **INGESTION HAZARD:** This product contains a button cell or coin battery.
- **DEATH** or serious injury can occur if ingested.
- A swallowed button cell or coin battery can cause **Internal Chemical Burns** in as little as **2 hours**.
- **KEEP** new and used batteries **OUT OF REACH** of **CHILDREN**
- **Seek immediate medical attention** if a battery is suspected to be swallowed or inserted inside any part of the body



How to Pair Remote Control and Solar Panel

If you ever lose or break your remote you can order a replacement and pair the new remote to your solar panel. You can also pair 1 remote to multiple panels so you can control several fountains simultaneously.

(Step 1) Hold the bottom left corner of the remote over the white 'O' mark on the panel.

(Step 2) When in the correct position a green light near the center spout will illuminate.

(Step 3) Hold the remote in the current position and press any button on the remote. The red light on the remote will illuminate and the green light on the panel will blink twice to indicate that it was successfully paired.

Now you can move the remote away from the panel.

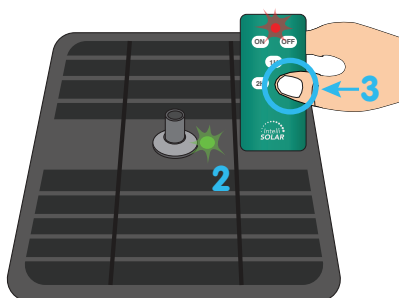
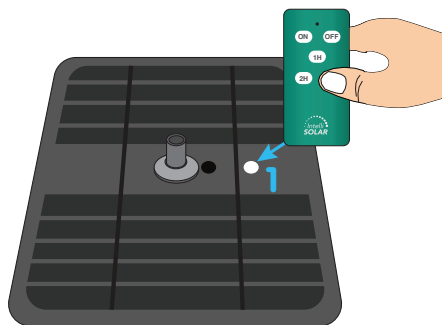

Cable Control Clips

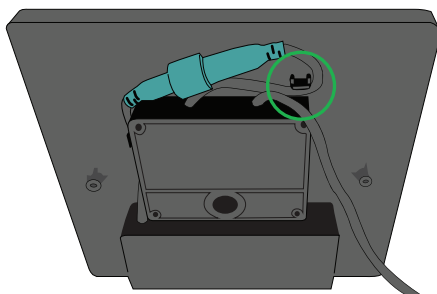
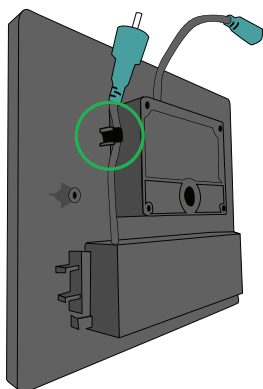

The bottom of the solar panel has cable control clips. They are tabs that you can use to hold the cables neatly in place if desired. Optional, not required.

Care and Maintenance

Your solar fountain is designed for outdoor use and with proper care will last for many years. The best way to preserve and extend the life of it is to clean it regularly and store it indoors for winter. There is a 1-year manufacturer's warranty on products that are properly maintained. Below are maintenance tips.

Pump

The pump needs to be cleaned regularly. We suggest once a week of possible or once a month minimum. Pull off the plastic filter cover and remove the mesh filter. Then pull out the impeller fan. Rinse all parts and wipe off the impeller magnet. Use a cotton swab to clean the impeller cavity. To keep the pump clean for longer periods by preventing algae from growing in the water, try Fountain Fresh (our all-natural non-toxic water clarifier which is safe for birds and pets).

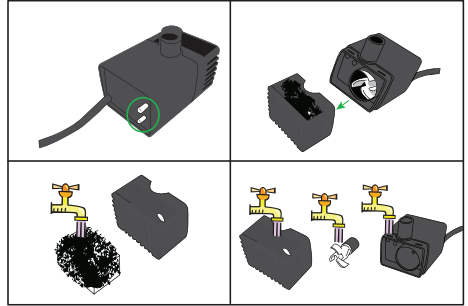

Solar Panel and Fountain Head

Clean the panel with glass cleaner or mild soap and cloth/cloth. To remove hard water build-up you can use vinegar and a sponge with scrubbing side. Unscrew the top cap of the sprayer to rinse out debris.

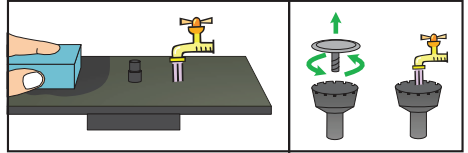

Battery

Rechargeable battery packs become less efficient with repeated charge and discharge cycles. The capacity of the battery may also reduce over time. If you find that the battery performance seems low, we first suggest boost charging it. To do this, leave off for 2-3 sunny days to fully charge to the battery. We suggest you do this occasionally anyway to help prolong the battery life. If boost charging, if your battery still does not perform well, you can seek a replacement battery from our parts department.

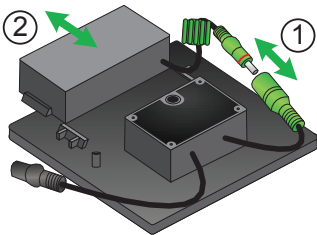

Replacing Battery

Unplug green battery connector (**step 1**) and slide out the battery pack (**step 2**). Replace with new battery and reconnect. Dispose of old battery according to local regulations



WARNING: Freezing temperatures and Winter Storage

Do not leave the fountain outside in winter if you get freezing temperatures in your area. Freezing can cause damage to the product. Before the temperatures get down to 0°C/32°F store the entire fountain in a frost-proof environment such as a shed, garage or basement. Any issues caused by freezing temps, snow, or ice from leaving it outside in the winter are not covered under the manufacturer's warranty.



Troubleshooting for 2-Tier Fountain

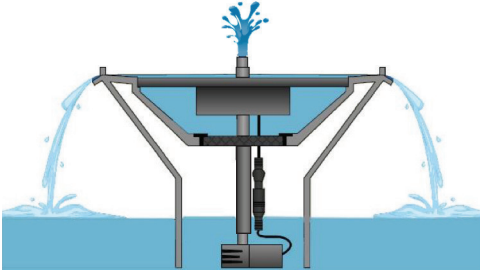

CORRECT ASSEMBLY AND PERFORMANCE: ✓

- Pump runs when in direct sun or in the shade if the battery is charged.
- Tube is inserted into bottom of panel so water will come out through the tube and the panel does not lift out or fall out.
- Foam disc seals the hole so the top tier fills up and overflows.
- Plugs have red rings covered to make a water tight connection.
- Pump sits at the bottom of the tier so it's fully submerged.

Issue: "It works but is weak" ✗

HOW TO FIX IT:

- The tube may not be connected to the bottom of the panel. If your panel lifts out easily or falls out when upside down that's the issue. Hold the panel in the top with one hand and squeeze them together to insert the tube into the bottom of the panel.
- If it doesn't lift out then the filter might be clogged. Clean the pump and solar panel as shown in the maintenance section.
- If that does not help the battery might be low. Turn off for 1-2 sunny days to charge the battery.

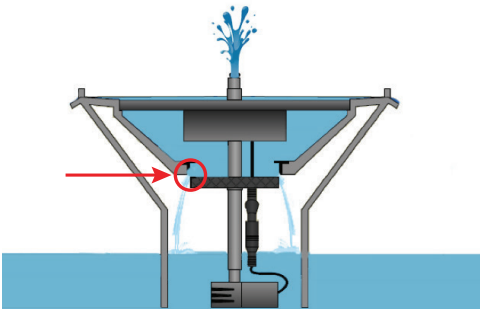

Issue: "It works but the top doesn't overflow" ✗

HOW TO FIX IT:

- The foam disc is not in the correct place so the water is running back down inside the tier to the pump. Ensure the foam disc is securely fitted into the hole with the wire tucked into the slit in the side of the disc. Push the disc up into the hole. It must be sealed to make the top fill up and overflow

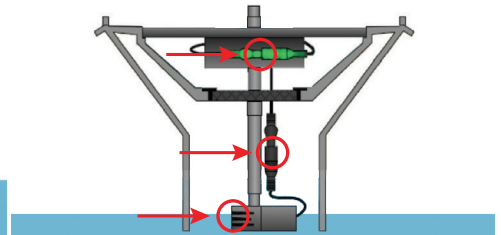

Issue: "The pump is not running at all" ✗

HOW TO FIX IT:

- Have the fountain in direct sun or charge the battery.
- Make sure the water level isn't too low. If the pump is dry it will not run. Add water to fill the bowl.
- Ensure the plug connections are tight and the red o-rings are not missing.
- Clean the pump filter and impeller.
- Clean the solar panel.
- Press ON or a timer button on the remote. Get closer if too far away.

Troubleshooting for IntelliSolar Fountain with Remote

Fountain works. Remote not working. Light on remote illuminates when pressing button:

- Fill the fountain full of water so the pump is fully submerged.
- If the pump is dry the water sensor will not let the pump run.
- Try pairing the remote with your solar panel again.
- Get closer to the fountain and point it at the solar panel.
- Press the button slower and hold it for a second.

Fountain works. Remote not working. Light on remote NOT illuminating when pressing button:

- Makes sure battery in remote is installed correctly. Replace battery in remote if needed.

Fountain works when in direct sun but NOT when in shade:

- Ensure the green plug for battery is connected and threaded water tight.
- Battery is low. (Option#1) You can continue to run it as-is in direct sun. (Option#2) You can turn it off using the remote to charge the battery in direct sun. (Option#3) You remove it from the water and place it in direct sun to charge. If after charging in direct sun for 1-2 sunny days it still doesn't work you may need to replace the battery.

Fountain works but weak:

- If not in direct sun then the battery is low. Use as-is or turn unit off to charge when in sun.
- If in direct sun then it may be dirty. Remove unit from water, disconnect plugs, ensure they are clean and dry and red o-rings are in place. Clean pump filter, remove white impeller to clean the magnet. Clean solar panel glass . Rinse out the sprayer. Reassemble the unit.

Can hear pump running but no water coming out of top of solar panel:

- When the pump is fully submerged then it's quiet so if you can hear it running then the water level is most likely too low so the pump is not submerged but the water sensor pins on it are still wet or dirty. Once the pins dry off the pump will automatically stop running or when the pump is fully submerged you will not hear it.
- If the water level is low and you want the fountain to work then add water to fill the bowl.
- If you don't want water in the bowl and don't want the pump to run then either use the remote to turn it off or check the water sensor pins on the back of the pump. If the pins are dirty then wipe them off. If the pins are wet then dry them off. Once the pins are clean and dry then the pump will automatically stop running.

Fountain not working at all:

- Ensure the pump is submerged. Fill the fountain with water until full. If the pump is dry the water sensor will not let the pump run.
- If you had a few cloudy days in a row and didn't turn it off then the battery is empty.
- If the water level is full and it's in direct sun in the middle of the day and not working then remove the unit from the water, dry it off and do the following steps: Ensure plugs are connected and water tight. Clean the pump filter, impeller, and water sensor. Clean the solar panel glass . Reassemble and place it back in the water. If necessary try to manually start it.
- When you press any button on the remote you should see a light on the remote illuminate. If not, then static electricity can sometimes help coin batteries. Trying removing the battery, and rub both sides between your thumb and finger or wrapped it in a cloth and rub both sides, then reinstall it. If that doesn't help then replace the battery. If you already tried a new battery then you can contact us to order a replacement remote.

WARNING FOR COIN BATTERY

1. Remove and immediately recycle or dispose of used batteries according to local regulations and keep away from children. Do NOT dispose of batteries in household trash or incinerate.
2. Even used batteries may cause severe injury or death.
3. Call a local poison control center for treatment information.
4. Battery type: CR2025
5. Nominal battery voltage: 3 V
6. Non - rechargeable batteries are not to be recharged. 7. Do not force discharge, recharge, disassemble, heat above 50°C or incinerate. Doing so may result in injury due to venting, leakage or explosion resulting in chemical burns.
8. Ensure the batteries are installed correctly according to polarity (+ and -).
9. Do not mix old and new batteries, different brands or types of batteries, such as alkaline, carbon - zinc, or rechargeable batteries.
10. Remove and immediately recycle or dispose of batteries from equipment not used for an extended period of time according to local regulations.
11. Always completely secure the battery compartment. If the battery compartment does not close securely, stop using the product, remove the batteries, and keep them away from children.

Warranty

Smart Living Home and Garden warranties your fountain for one (1) year from the original date of purchase from authorized distributors and retailers. The warranty covers parts that are properly installed and regularly maintained. If the product fails due to a defect in material or workmanship, Smart Living will replace the defective parts free of charge. Your fountain will last for many years with proper care. Any parts damaged by freezing temps are not covered under warranty.

Please unpack and inspect the entire product upon receipt. Report any broken or missing pieces within five (5) business days of receipt to and we will provide replacement parts free of charge. Please do not discard any damaged parts until instructed to do so.

Thank You!

Thank you for purchasing a Smart Living Home & Garden product. Welcome to the family! You can visit our website to register your product, leave a review, check out our FAQ page, or order replacement parts. Our products are thoughtfully designed by a dedicated team based in the USA. While we aim high, we acknowledge that defects can occur as part of the manufacturing process. If our QC team missed something and you experience an issue we apologize for the inconvenience. Please contact us using the info below.



Smart Solar is a Smart Living Home & Garden brand

Telephone: + 1 813 343 5775

Email: customerservice@smartlivinghg.com

Web: www.smartlivinghg.com

Patented Technology from Smart Solar. US Patent 12,196,192

1 Year Limited Manufacturer's Warranty

