

Dual Panel Solar Fountain

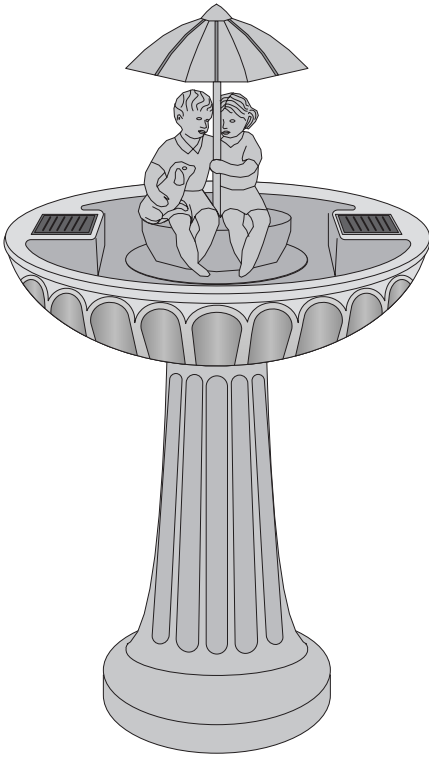

* Styles may vary but assembly will be consistent with this manual



Umbrella Style

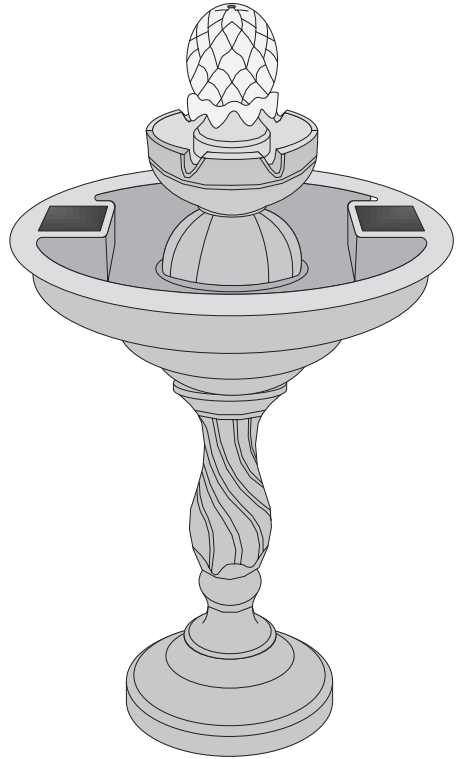

Sculpture Style

Warnings



Water must be regularly topped off. We recommend regularly changing the water to ensure it remains clean and free from debris.



Important!

Frost causes damage, store whole product inside during cold weather.

Umbrella Style Fountain Assembly

1. Attach the main bowl to the pedestal. Align the marks and turn to lock in place.
2. Place the solar panels in the recesses provided running the cables through the holes in the side.
3. Connect the solar panels to the pump taking care to ensure the connectors are water tight. Push the plugs together until they touch the rubber o-ring, slide the threaded cap over the plug and turn the cap until tight.

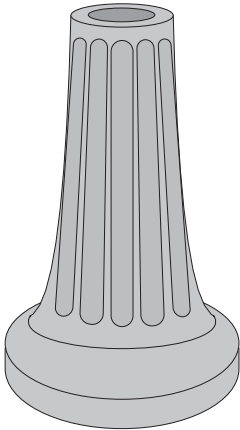
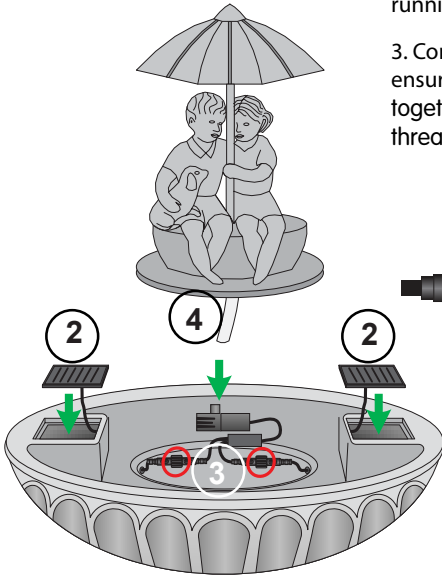

! Important

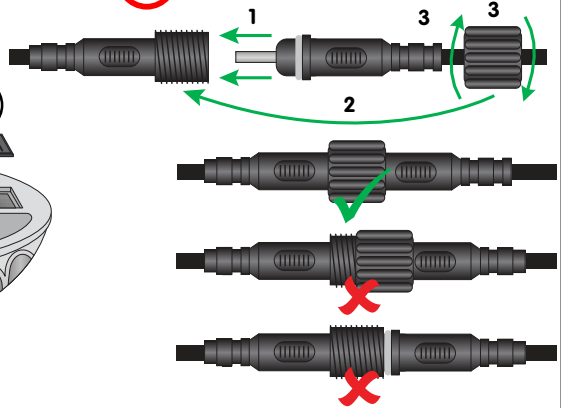

4. Connect the hose from the umbrella statue to the pump and lower it into place. Ensure the pump and cables are nearly stored in the recess provided.
5. Fill the main bowl with water.

Note: Water must be regularly topped off. We recommend regularly changing the water to ensure it remains clean and free from debris.



Sculpture Style Fountain Assembly

1. Attach the main bowl to the pedestal. Align the marks and turn to lock in place.
2. Place the solar panels in the recesses provided running the cables through the holes in the side.
3. Connect the solar panels to the pump taking care to ensure the connectors are water tight. Push the plugs together until they touch the rubber o-ring, slide the threaded cap over the plug and turn the cap until tight.

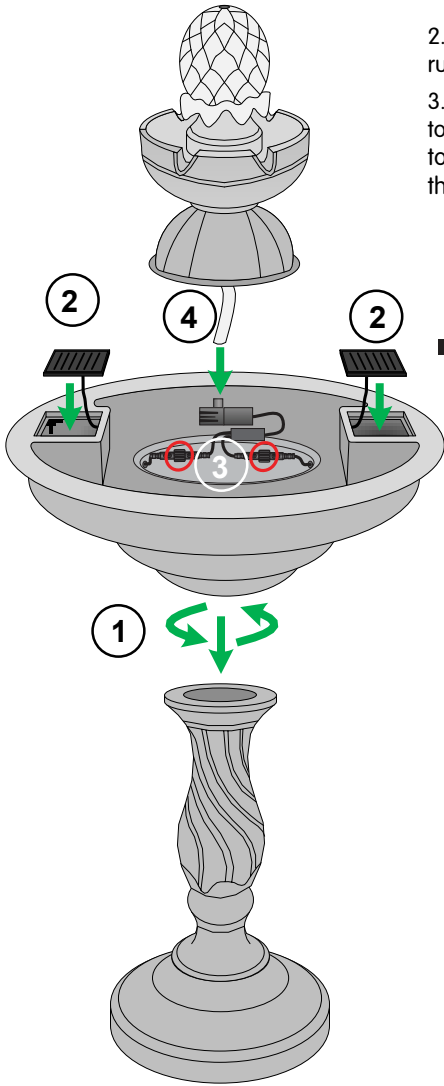

! Important

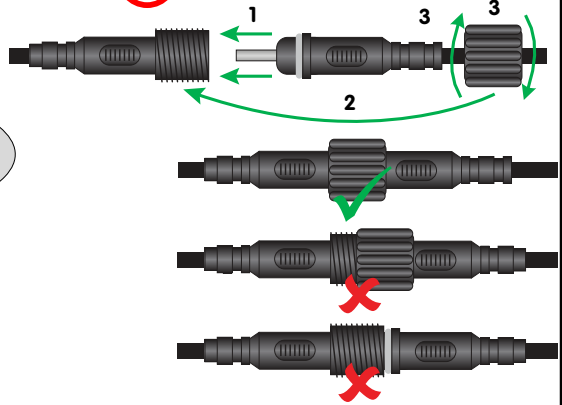

4. Connect the hose from the pineapple to the pump and lower it into place. Ensure the pump and cables are neatly stored in the recess provided.
5. Fill the main bowl with water.

Note: Water must be regularly topped off. We recommend regularly changing the water to ensure it remains clean and free from debris.



Position

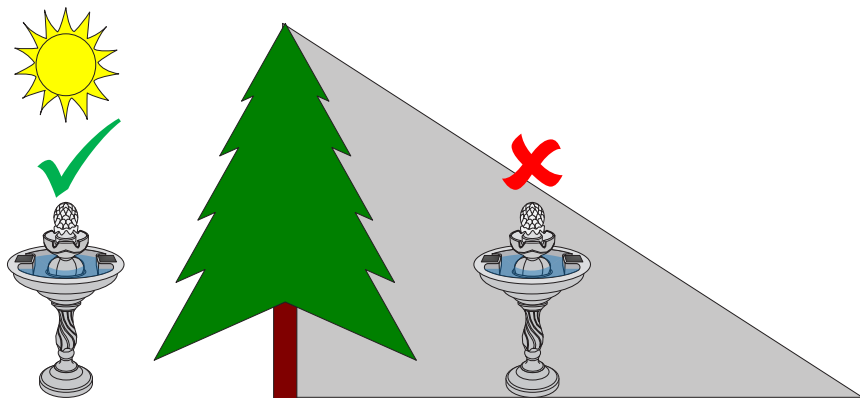

Position your fountain so that receives direct sunlight. The fountain will NOT work if the solar panels are in a shaded area.

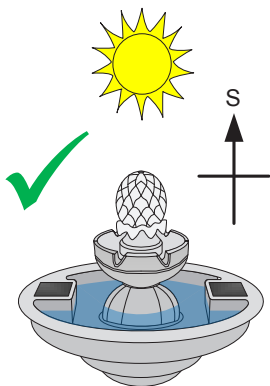

In order to minimize the chances of the finial shading one of the solar panels ensure that the fountain is south facing. If shading does occur simply rotate the fountain until the panels are in sunlight.

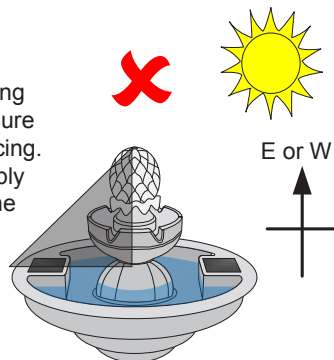

Warnings



Water must be regularly topped off. We recommend regularly changing the water to ensure it remains clean and free from debris.

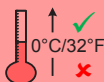

Important!

Frost causes damage, store whole product inside during cold weather.

Performance

This product is designed primarily to operate in summer months but will also work in spring and autumn provided there is good sunshine. Performance is directly related to the amount and strength of sunlight received.

Sculpture

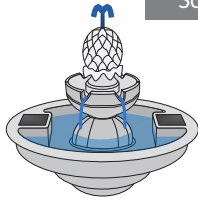
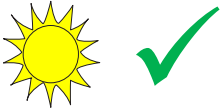

In bright direct sunlight your pump will work well with a consistent fountain height and flow rate.

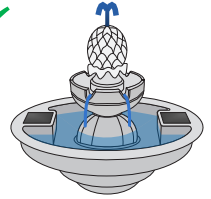

In slightly cloudy conditions your pump will work however fountain height and flow will vary as clouds pass in front of the sun.

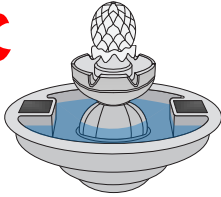

In overcast conditions the solar panel does not generate enough power to run the pump and it will NOT work.

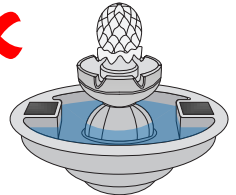

At night the solar panel does not generate power and your pump will NOT work.

Umbrella

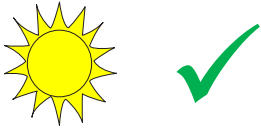

In bright direct sunlight your pump will work well with a consistent fountain height and flow rate.



In slightly cloudy conditions your pump will work however fountain height and flow will vary as clouds pass in front of the sun.



In overcast conditions the solar panel does not generate enough power to run the pump and it will NOT work.



At night the solar panel does not generate power and your pump will NOT work.

Connections

! Important

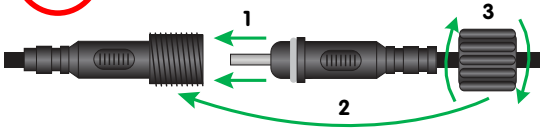

Ensure connections from both solar panels to pump are water tight.

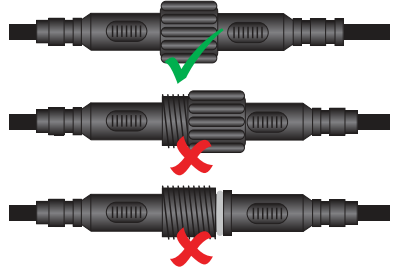

Pump Cleaning / Troubleshooting

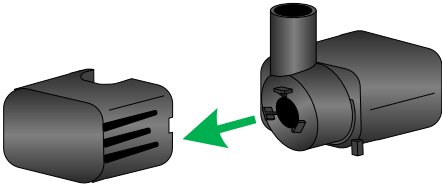

Filter cover can simply be pulled apart as shown.

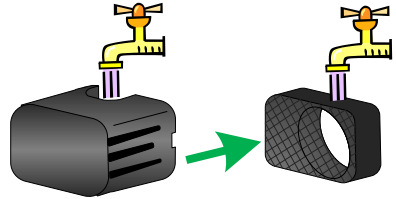

Remove filter material and rinse in water.

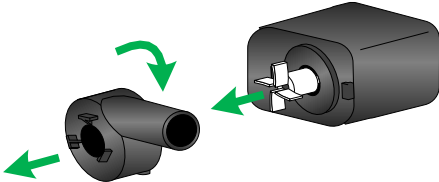

Turn off impeller cover to release as shown, impeller can be easily removed

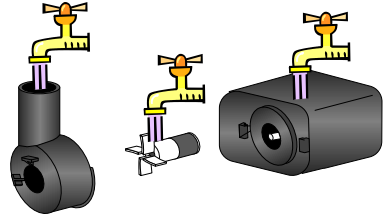

Rinse all parts thoroughly in water. Use cotton swab to clean the inside of pump housing where the impeller sits

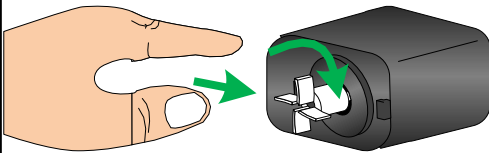

If the pump is not working immediately, try the following for a manual start. Remove the pump cover. Remove the impeller cover, face the panel to the sun, and start manually spinning the impeller clockwise, this can take a minute.

Maintenance

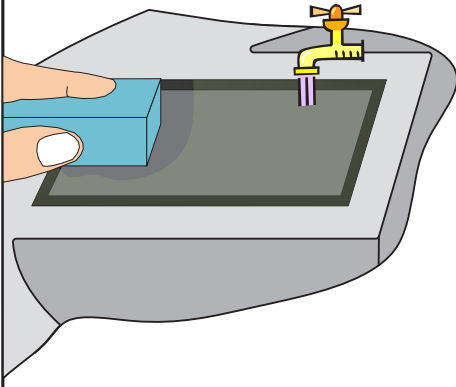

To maintain optimum performance, regularly clean the solar panel using water or glass cleaner in conjunction with a non-abrasive sponge or cloth.

Umbrella

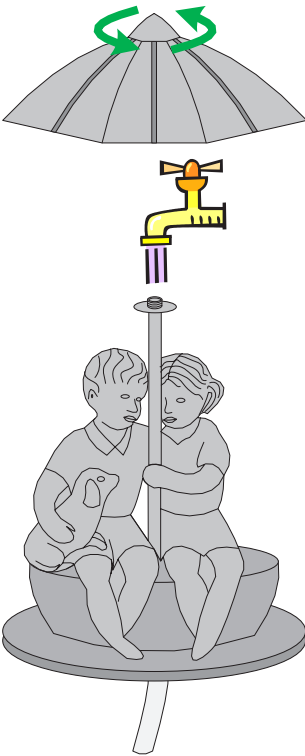

Remove umbrella to access tube. If the tubing become blocked, rinse through with water.

Sculpture

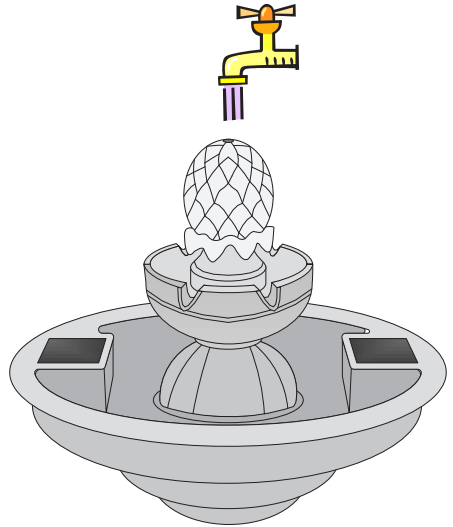

If the tubing become blocked, rinse through with water.

Thank you for purchasing this Smart Solar fountain.

Register your Product Here:

<https://smartlivinghg.com/wp/customer-service/product-registration/>

FAQs are available online along with step by step video tutorials to help you with pump cleaning and solar kit assembly.

Visit: <https://smartlivinghg.com/wp/customer-service/faq/>

PROBLEM	RESOLUTION (and page for reference)
The fountain is in sun but the pump is not working.	1. Ensure the connections are secure and that pump tube is connected to underside of solar panel – see pg 7 for Assembly 2. Pump needs manual start - see pg 6 Pump Troubleshooting
No water flow from the top of the fountain.	1. Try manual start on pump – see pg 6 2. Ensure the tubes from pump are connected to the underside of the sculpture - see pg 2-3 for Assembly

Smart Living Home & Garden warranties your solar panel, pump and battery (for Solar-on-Demand units) for one (1) year from the original date of purchase from authorized distributors and retailers. The warranty covers parts that are properly installed and regularly maintained. If the product fails due to a defect in material or workmanship, Smart Living will replace the defective parts free of charge. Your fountain is designed for outdoor use and with proper care will last for many years. If over time your fountain develops scratches or minor wear from normal use, you can contact our customer service department for easy to apply one step touch up paint.

Please unpack and inspect the entire product upon receipt. Report any broken or missing pieces within five (5) business days of receipt to our customer service department and we will provide replacement parts free of charge. Please do not discard any damaged parts until instructed to do so by our customer service department.



smartLiving
home & garden

Smart Solar is a Smart Living Home & Garden brand

Telephone: + 1 813 343 5775

Email: customerservice@smartlivinghg.com

Web: www.smartlivinghg.com